

EXAMPLES OF CORRODED GLANDS



EXAMPLES OF CORRODED GLANDS



• **CORROSION**

- Aggressive chemicals and moisture in petrochemical / oil and gas industry corrode any exposed brass cable glands.
- Bi-metallic corrosion e.g. between aluminium and brass.



CLOSE UP OF CORRODED CABLE GLANDS



CCG SCREW ON CORROSION GUARD™

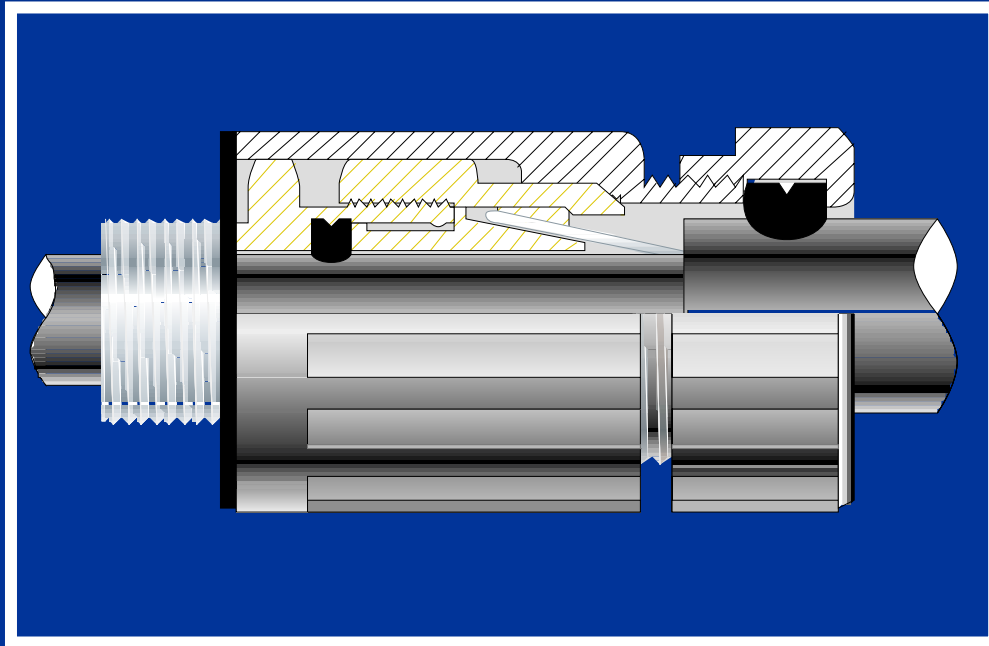

CCG SOLUTION TO CORROSION OF CABLE GLANDS

Make sure the gasket ① is in place.

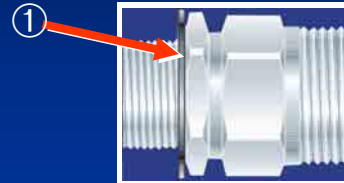

Screw gland inner ② strip outer sheath and pass corrosion guard ③ and gland outer nut ④ over cable. Pass cable end through inner and spread out armour wire.

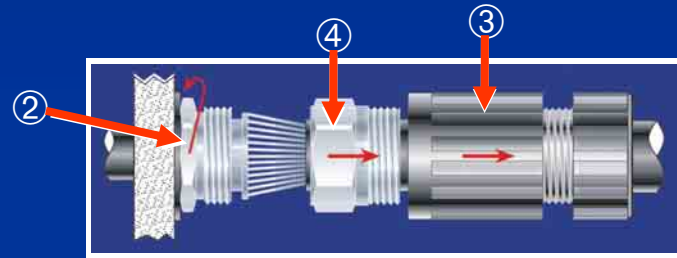

Screw gland outer body ④ onto inner ② and tighten.

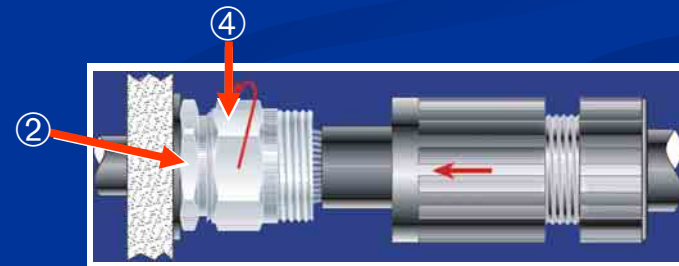

Pass corrosion guard body ③ and outer nut ⑤ over assembled gland, screw on and hand tighten to produce the required dust and water proof seal IP68. (No tools required)

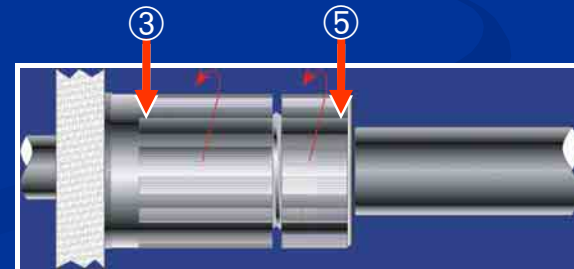

PROBLEM

LOOSE FITTING SHROUDS



CCG SOLUTION

**CCG SCREW ON
CORROSION GUARD™**

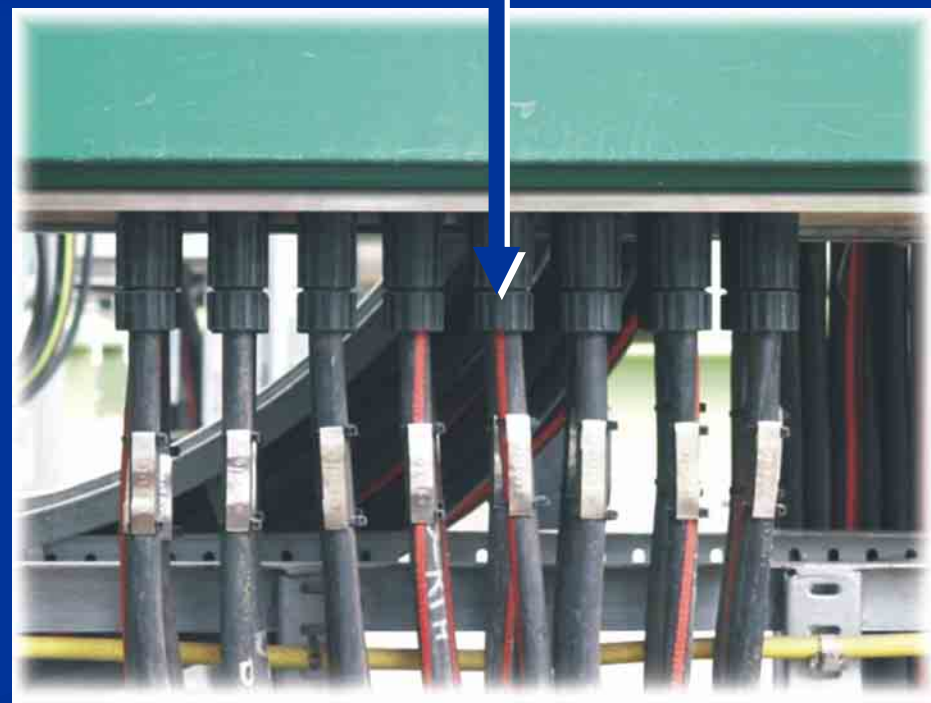

PROBLEM

CORROSION

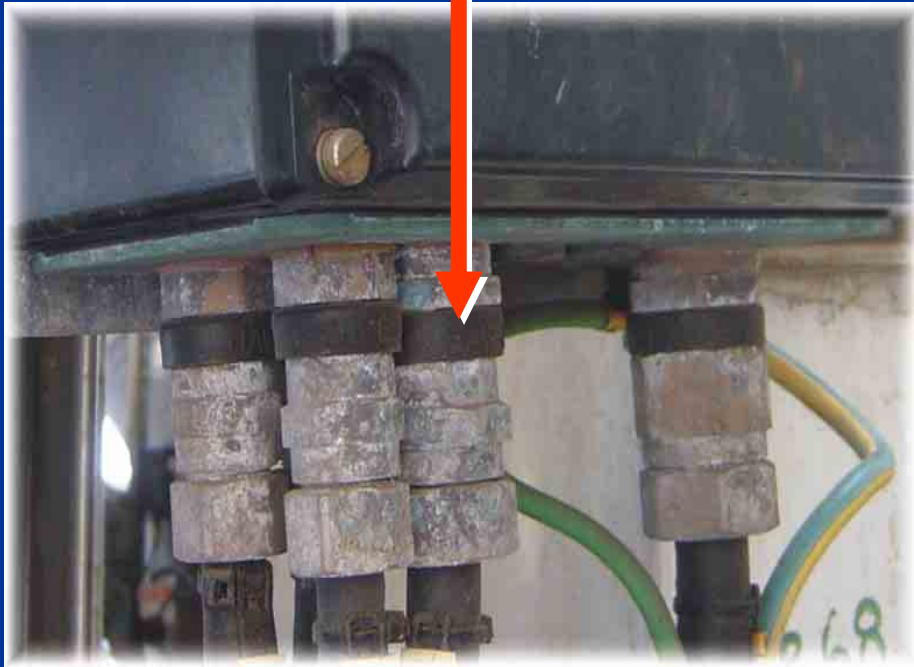

CCG SOLUTION

**CCG SCREW ON
CORROSION GUARD™**

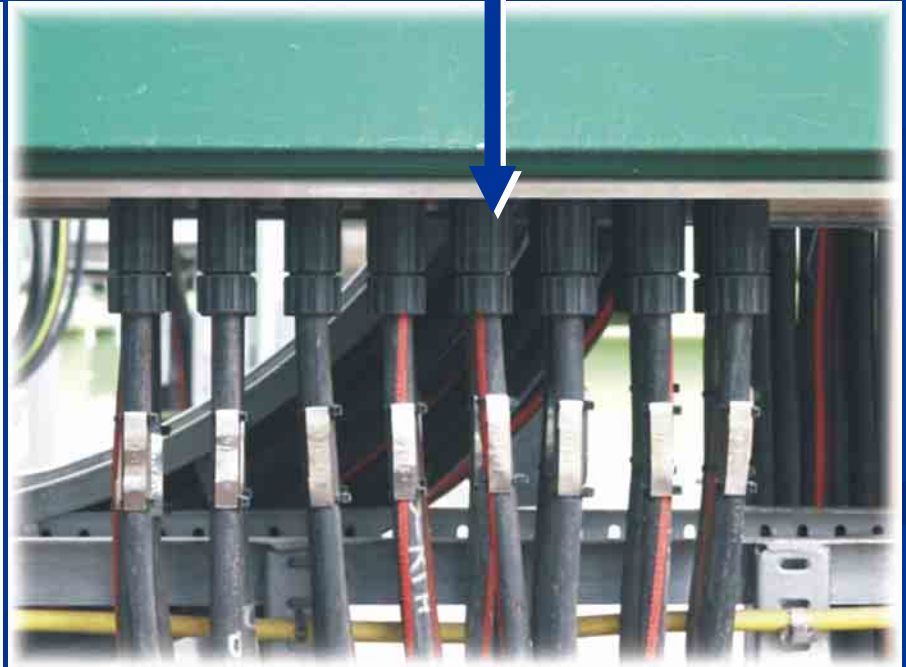

PROBLEM

**CORRODED GLANDS ON A
LIGHT FITTING**



CCG SOLUTION

CCG Screw on Corrosion Guard™



PROBLEM

**LOOSE FITTING SHROUDS
AND CORRODED GLANDS**

CCG SOLUTION

**CCG SCREW ON
CORROSION GUARD™**



PROBLEM

CORROSION

CCG SOLUTION

CCG SCREW ON CORROSION GUARD™

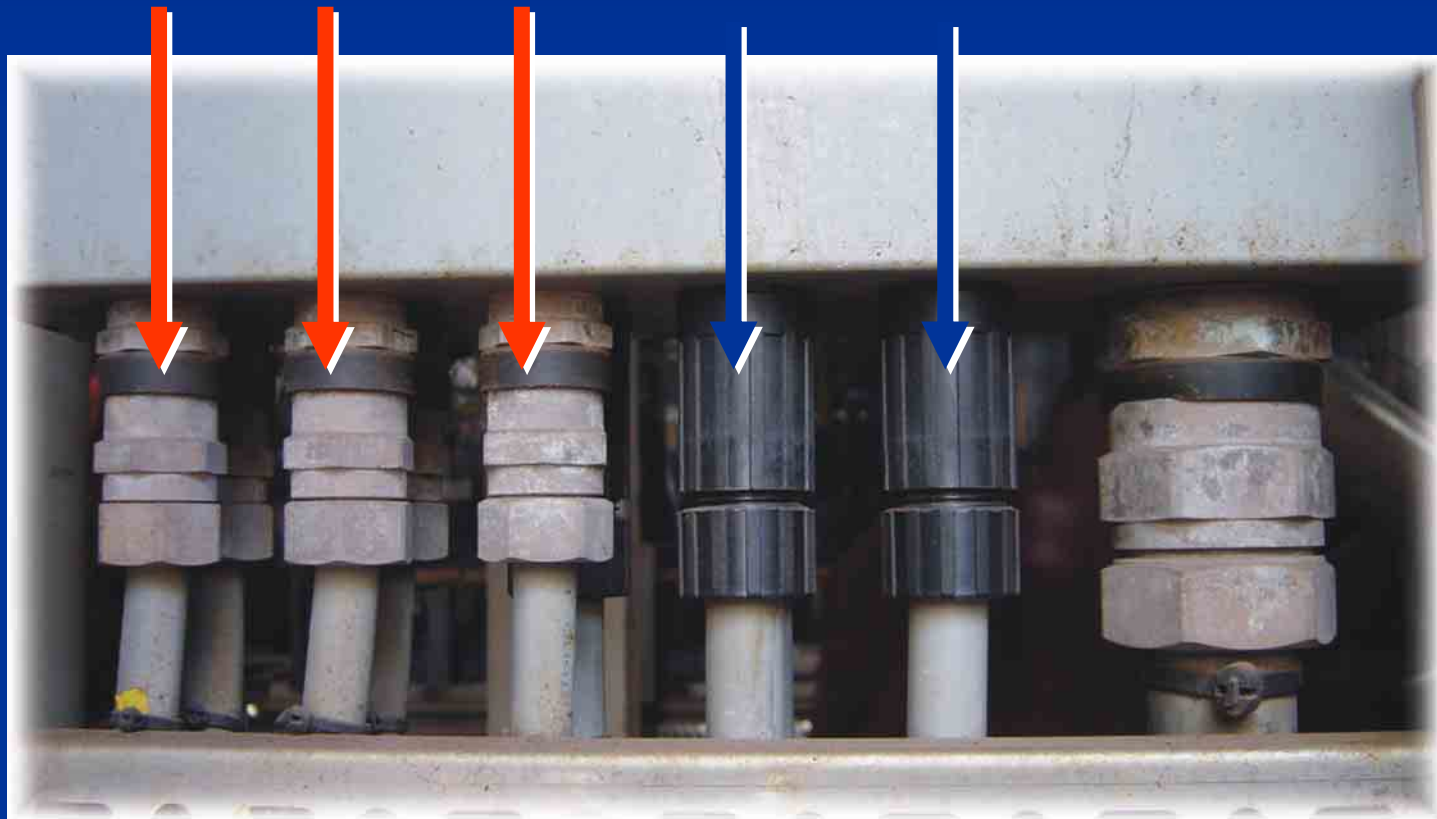

**CCG SCREW ON CORROSION GUARD™
ON A CCG Exe POSI BOX**

